

MEGAWARE



KeelGuard **Pontoon**Guard **Skeg**Guard **Skeg**Pro **Scuff**Buster **FlexStep**Pro



**EXPERTS IN PROTECTING
YOUR WATER CRAFT**



In 1992 Megaware developed KeelGuard, the industry's first patented, do-it-yourself keel protector, and has been providing boat owners with the highest quality protection ever since, including hull and gelcoat protection, pontoon tube protection, skeg protection, and others.

From the beginning, Megaware has been committed to excellence in product development, quality standards, technology and customer support. Megaware is rapidly growing and is recognized as a worldwide supplier for the smallest fishing boats to the largest coast guard fleets.

As new technologies emerge, Megaware will incorporate these advancements to further enhance its line of cutting edge, easy-to-use products. Don't trust your investment to anything less.



KeelGuard

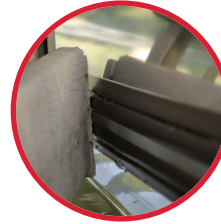

PontoonGuard

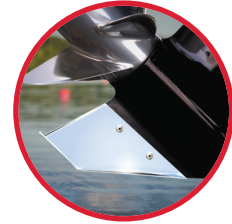

SkegGuard



SkegPro



Scuff Buster



FlexStep Pro

MEGAWARE

KeelGuard[®]

**THE ORIGINAL
DO-IT-YOURSELF
KEEL PROTECTOR**

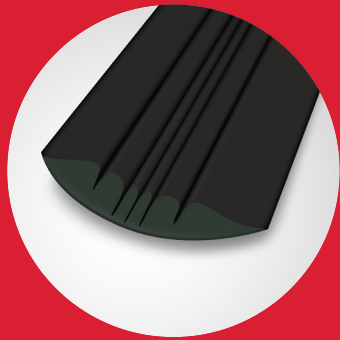

MEGAWARE KEELGUARD

801.334.5335



3M® TECHNOLOGY

All Megaware KeelGuard Products Use the Highest Quality Materials and 3M Premium Adhesives.

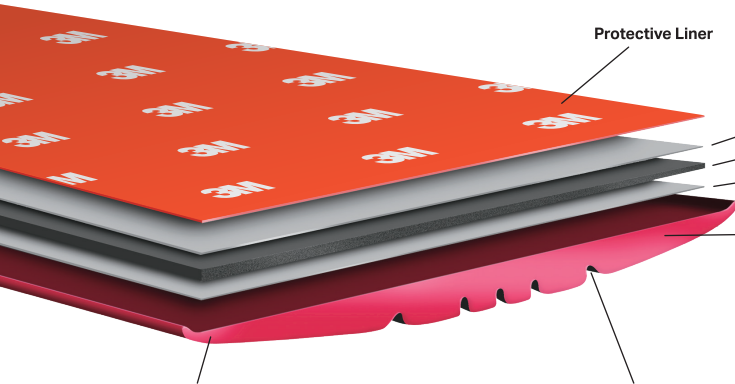

Protective Liner

Acrylic Adhesive

Acrylic Foam Core

Acrylic Adhesive

PLIABLE AND TOUGH

Ultra-Tough Polymer Composite

- Pliable, Conforms to Keel
- High-Quality Polymers and Urethanes
- Shock Absorbent

CONTOURED EDGE

- Creates a Clean, Tight Seal
- No Messy Sealants Needed

RESEARCH AND TECHNOLOGY

Hydrodynamic Drag Reduction Channels

- Patented Drag Reduction Design
- Angled Grooves Create Air Pockets and Provide a Slicker Surface
- Will Not Slow Your Boat Down

THE RIGHT BALANCE

3M Acrylic Pressure-Sensitive Adhesive

- 3M Adhesive Self-Seals to Hull Surface
- Right Balance of Strength and Bonding



- **Protect Against Abrasive Sand, Rocks, Concrete Ramps, and Oyster Beds**
- **Eliminate Costly Repairs**
- **Enjoy the Highest Quality and Superior Engineering**
- **Increase the Value of Your Boat**

Wear and damage to your boat's keel can break down its protective gelcoat finish, allowing water to reach and destroy the fiberglass laminates. Megaware KeelGuard, the powerful abrasion-resistant protector, prolongs the life of your boat like nothing else.

Megaware KeelGuard Patented Engineering

Every aspect of the patented Megaware KeelGuard has been developed with boat designers and 3M engineers. Many factors contribute to its success. A precise, abrasive-resistant blend of polymers and urethanes achieve optimal durability and pliability. A pressure-sensitive 3M adhesive creates strength, while permanently bonding and sealing the Megaware KeelGuard contoured edges to the hull surface. Angled grooves produce hydrodynamic channels, creating air pockets and providing a slicker surface. The perfect combination of these factors makes the Megaware KeelGuard the easiest keel protector to install, providing unparalleled quality and dependability.

KeelGuard.com

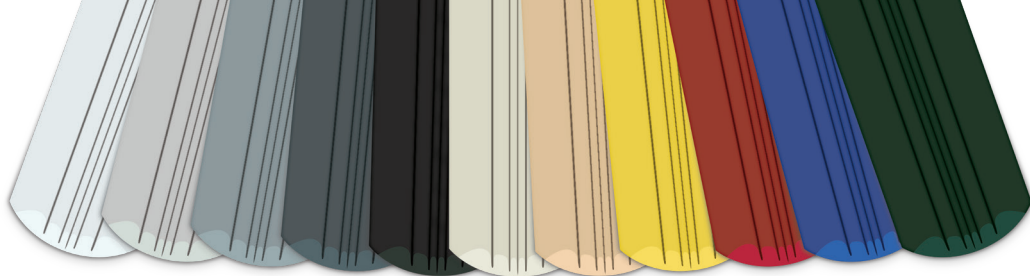

White Light Gray Gray Charcoal Black Almond Sand Yellow Red Blue Hunter Green

Enhance Your Watercraft

Megaware KeelGuard's sleek lines and contoured shape enhance the performance and look of your watercraft. Its engineering and aesthetics remain second to none.

KeelGuard Lengths and Colors

Megaware KeelGuard comes in 11 great looking colors to match virtually any boat. All colors are UV-stabilized for true color that lasts a lifetime. Megaware KeelGuard is available in nine standard lengths or can be ordered in custom lengths.



Size Chart

KeelGuard	Boat Size
4 ft	Up to 14 ft
5 ft	Up to 16 ft
6 ft	Up to 18 ft
7 ft	Up to 20 ft
8 ft	Up to 22 ft
9 ft	Up to 24 ft
10 ft	Up to 26 ft
11 ft	Up to 28 ft
12 ft	Up to 30 ft
Call toll-free 1.800.292.9835 for custom sizes	

Product Width: 5"



Trusted Protection

As seen on Ship Shape TV and featured on Aaron Martin's Bass Edge Podcast, Megaware KeelGuard is the first choice for boat hull protection by many professional fishermen and is installed on every Major League Fishing boat.



Megaware KeelGuard has been protecting watercraft of all kinds, including recreational boats, fishing boats, dinghies, rigid inflatables, and coast guard fleets.

Do-It-Yourself Easy Application in 4 Basic Steps

Installs Easily in an Hour or Less



- 1 **ETCH** with Scotch-Brite Pad
- 2 **CLEAN** with Alcohol (Not Included)
- 3 **PRIME** with 3M Primer
- 4 **APPLY** with Burnishing Tool

Note: If your trailer is designed with the boat resting on center rollers or a support beam along the keel, we do not recommend installing a keel protector. If the rollers can be lowered or the side bunks raised to clear the roller, the Megaware KeelGuard adhesive bond will not be compromised. The Megaware KeelGuard is not suitable for some aluminum boats, pontoons, catamarans, personal watercraft, or boats with a non-standard V shaped keel. Please call for suitability.

Included Do-It-Yourself Application Kit



- Patented Burnishing Tool
Insures Professional Results
- No Extra Tools Needed

"I would just like to compliment you on your clear instructions and a wonderful product. I installed it in about 45 minutes, and it truly looks as if it were part of the original manufactured vessel."

Martin C. Megaware KeelGuard Customer

Machine-Tapered Ends
Aid in the Reduction of
Drag or Snags

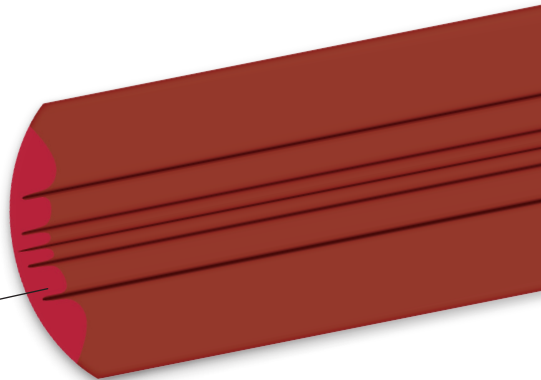

MEGAWARE
KeelGuard[®]

LIFETIME WARRANTY

Megaware KeelGuard is so tough and reliable that we include a lifetime warranty. Megaware KeelGuard is guaranteed to protect your boat for life. In the unlikely case in which problems arise, we replace it for free. It really is that simple.

KeelGuard.com

MEGAWARE

PontoonGuard[®]

**PROTECT EXPOSED &
VULNERABLE AREAS OF
YOUR PONTOON**

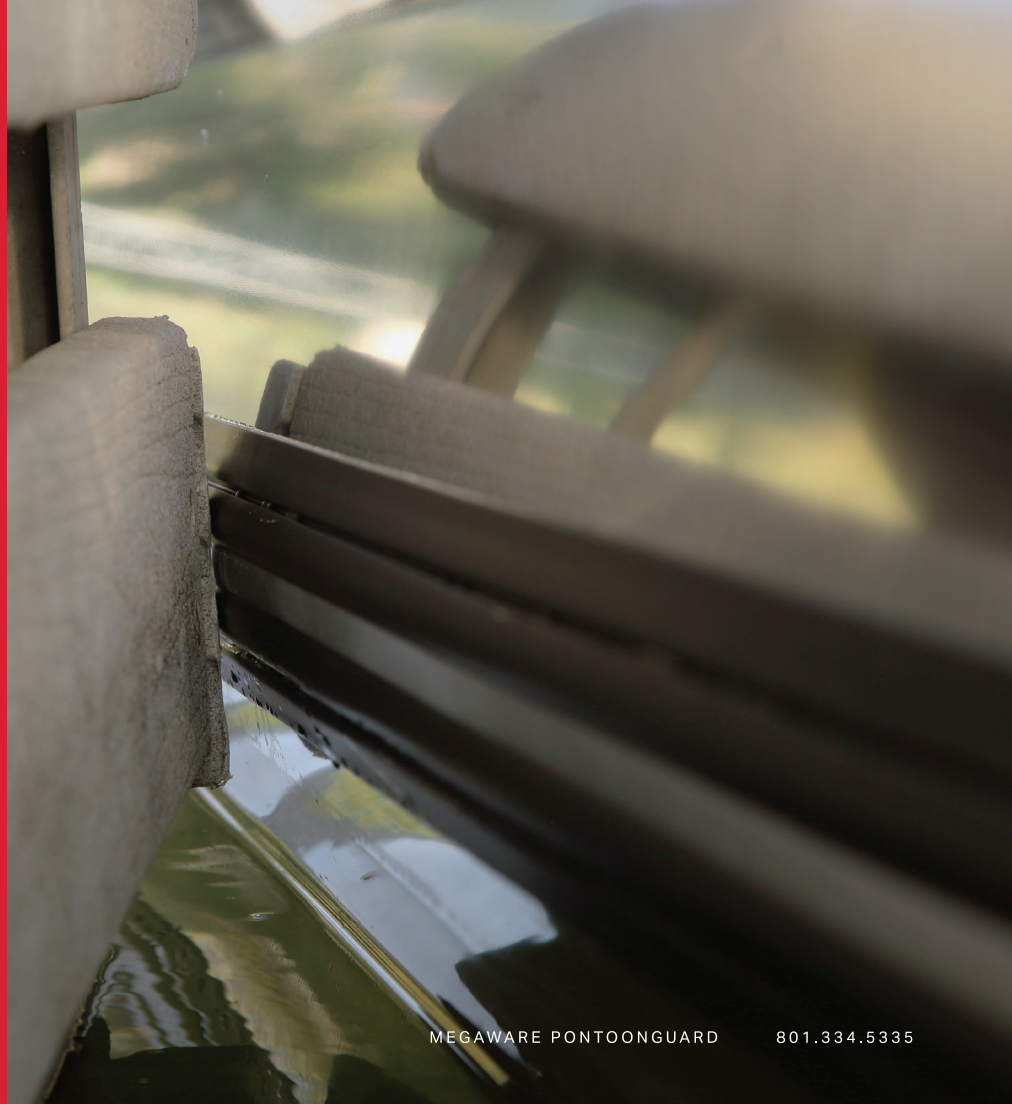
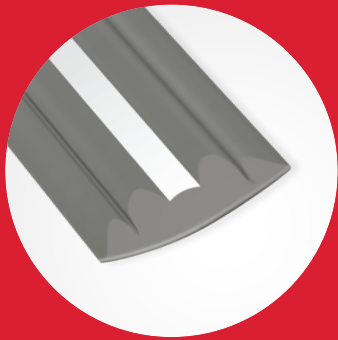



Protect & Customize Your Pontoon While Increasing Safety

Megaware PontoonGuard is a custom engineered protection and safety product designed specifically for the pontoon boat market.

Megaware PontoonGuard provides protection to the side of the tubes against abrasion and chafing caused by docks, other pontoons, and hidden obstacles.



SUPER STRONG ¼ INCH THICK ULTRA-TOUGH POLYMER COMPOSITE

For Maximum Durability

3M
ADHESIVE SYSTEM

3M® REFLECTIVE STRIP

Increases Visibility and Safety

T
3.5"
T

CONTOURED SIDES

For a Clean, Tight Seal

MACHINED CONTOURED LEADING EDGE

For a Sleek, Streamlined Look

Sizes

For Pontoons up to 21 ft.

32 ft Kit - (2) 16 ft. Length
Megaware PontoonGuards

For Pontoons 22-25 ft.

40 ft Kit - (2) 20 ft. Length
Megaware PontoonGuards

Colors



Black

Gray

Red

Blue

MEGAWARE
PontoonGuard®

- **Protect Vulnerable and Exposed Areas of Your Pontoon**
- **Make Your Vessel More Visible During Night Operations or While Anchored or Beached**
- **Avoid Unsightly Dents, Scratches, and Scrapes from Docking Your Pontoon**
- **Add a Custom Sleek Look to Your Pontoon**
- **3 Year Warranty**

Megaware PontoonGuard incorporates a 3M reflective strip to enhance the visibility of the pontoon in nighttime or low-light conditions when illuminated by a light source such as headlights or search lights. This can be useful either on or off water while beached, anchored, trailered or parked.

KeelGuard.com

MEGAWARE

Skeg Guard[®]

**THE INEXPENSIVE
SOLUTION TO A BROKEN
OR DAMAGED SKEG**



Megaware SkegGuard Engineering

Megaware SkegGuard is constructed of high quality marine grade 316 stainless steel that incorporates an extra reinforced wear tab across the bottom where the skeg is most vulnerable. This 3mm thickened lower plate will withstand damage or abrasion from hidden rocks and debris or accidental ramp dragging. Megaware SkegGuard conforms to your lower unit to insure there is no discernable drag or compromise in performance. Each kit comes with self locking mounting hardware and hex wrenches.

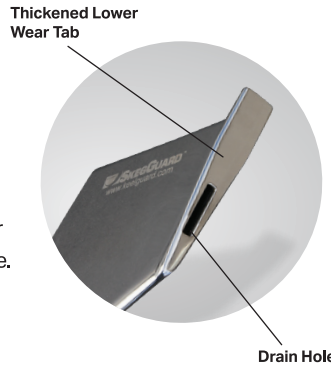

Model Guide

For motors not listed use our model finder tool at keelguard.com

EVINRUDE/JOHNSON <i>"Does not fit Lightning Gearcase"</i>	135-150-175-200 Optimax 2 Stroke 2005-2011	27411 175-200-225 4 Stroke, Pro XS 4.8" Gearcase 2019
27131 40-50-55-60 2 Stroke 2002-Present 65 1996-2012		27412 200-225-250-300 Pro XS Torque Master 4.8" Gearcase 2019
27121 65 2 Stroke 2013-2015 75 2 Stroke 2007-2015 90-115-130 20" Shaft 2006-Present		NISSAN/TOHATSU
27101 JOHNSON 100-115-120-140 1980-2001	27021 MERCUISER Alpha I 1985-1990	27071 70-90-115-120-140 2 Stroke 1993-2010
27081 90-115-130 25" or 30" Shaft 2006-Present	27031 MERCUISER Alpha I Generation II 1991-Present	SUZUKI
150-175-200-20" Shaft E-TEC 2006-Present	27051 MERCUISER Bravo I & III 1990-Present	27141 150-175-200-225 4 Stroke 2003-2011 150-175-200-225 2 Stroke 1986-2002
27091 135-175-200 25" or 30" Shaft E-TEC 2 Stroke 2006-2014	27011 MERCUISER Pre-Alpha I Drives 1973-1984	27151 250SS & 300 DF 4 Stroke 2006-2011
225-250-300 E-TEC 2002-2014	27071 40-50-60 Bigfoot 2001-2013 40-60 Command Thrust 2014-Present	27171 40-50-60-70 DF 4 Stroke 2003-2011
27281 150-175-200-250-300 E-TEC G2 2015-Present	50 Command Thrust 2014-2016 75-90-115-125 2 Stroke & Optimax 2003-2014	27261 90-115-140 DF 4 Stroke 1998-2011
HONDA	27341 75-90-115 4 Stroke 2003-2013 40-60 2&4 Stroke 2003-2017	27081 300 DF 4 Stroke 2009-2011
27171 35-40-45-50 4 Stroke 1991-2011 90 4 Stroke & V-TEC 2008-Present	50 2 Stroke 2006-2014 50 4 Stroke 2016-Present 55 2003-2011	YAMAHA
27071 60-75 4 Stroke 2010-2011 75-90-115 4 Stroke 1995-2007	27211 90-115 Command Thrust & ProXS CT 2014-Present	27321 50-60 High Thrust 4 Stroke 1996-Present 60-70-90 2 Stroke 1995-2009 70-75-80-90-100 4 Stroke 2003-2016
27271 115 4 Stroke 2010-2011 135-150-200-225 4 Stroke 2004-2011	150-175-200-225-250-275-300 Verado 4.8" Gearcase 2005-2018 200-225-250 Optimax & ProXS 2 Stroke 1999-2018 (<i>not compatible with Torque Master</i>)	27331 30-40-50 2 & 4 Stroke 2001-Present 60 4 Stroke 2002-Present
MARINER	27061 75-90-115 4 Stroke 2015-Present 135-150-175-200 2 Stroke &XR6 2000-2005	27151 150-175-200 2 & 4 Stroke & HPDI 1984-Present 350 4 Stroke 2007-Present I/O Stern Drive Models 1989-1993
27341 40-50-60 2 & 4 Stroke 2003-2011	150-175 Optimax & ProXS 2001-2016	27291 90 4 Stroke 2017-Present 115-130 2 & 4 Stroke 2001-Present
27071 50-60 Bigfoot 2003-2011 70-90-100-115-125 Incl. Opti 2 & 4 Stroke 1983-2011	27311 225-250-300-350 Verado 5.44" Gearcase 2014-2018	27041 -VMAX HPDI & SHO 200-225-250 4 Stroke VMAX SHO 2013-Present 200-225-250-300 2 Stroke VMAX HPDI 2004-2010
27211 150-175-200-225-250-275-300 Verado 2005-2011		27301 200 4 Stroke V6 2002-2016 225-250-300 2&4 Stroke 2004-Present
27061 135-150-175-200 2/4 Stroke & Optimax 1978-2005		

MEGAWARE
SkegGuard[®]

- **Mirror Polished 18 Gauge Marine Grade 316 Stainless Steel**
- **Thickened Lower Wear Tab Protects Against Ramp Dragging and is Great for River Running**
- **Drain Hole Prevents Corrosion and Freezing**
- **Won't Compromise Performance**
- **Do-It-Yourself Install in Less Than 10 Minutes**
- **Installs with as Little as 2-3 Inches of Skeg Remaining**
- **Avoid Expensive Repair Costs**
- **3 Year Warranty**

Megaware SkegGuard both protects and prevents damage to your motor's skeg and can also be used to repair and replace an already broken skeg.

MEGAWARE

SkegPro[®]

**STOP DAMAGE TO YOUR
BOAT'S SKEG BEFORE IT'S
TOO LATE**



Without

Megaware SkegPro Skeg Protector

Megaware SkegPro protects your motor's skeg against harsh marine environments. Its mirror-polished stainless steel creates a custom look and provides lasting protection.

Model Guide

For motors not listed use our model finder tool at keelguard.com

EVINRUDE/JOHNSON **Does not fit Lightning Gearcase*

- 658** 40-50-55-60 2 Stroke 2002-Present
65 2 Stroke 1996-2015
75 2 Stroke 20" Shaft 2007-2015
90-115-130 20" Shaft 2006-Present
- 664** 90-115-130 25"-30" Shaft 2006-Present
150-175-200 20" Shaft E-TEC 2006-Present
- 673** 135-175-200 25"-30" Shaft E-TEC 2006-2014 (No G2)
150 25"-30" Shaft E-TEC 2006-Present
225-250-300 2002-2015 E-TEC (No G2)
- 674** 150-175-200-250-300 E-TEC G2 2015-Present

HONDA

- 658** 115 4 Stroke 2010-2011
135-150-200-225 4 Stroke 2004-2011

MARINER

- 665** 40-50-60 2 & 4 Stroke 2003-2011
- 655** 50-60 Bigfoot 2003-2011
70-90-100-115-125 Optimax 2 & 4 Stroke
1983-2011
135-150-175-200 Optimax 2 Stroke 1978-2011
135-150-175-200 4 Stroke 1978-2005
- 656** 150-175-200-225-250-275-300 Verado 2005-2011

MERCURY

- 655** Mercruiser Pre-Alpha I Drives, Alpha I,
Alpha I Generation II
- 667** Mercruiser Bravo I & III 1990-Present
- 668** Mercruiser Bravo II 1994-2018
- 655** 40-50-60 Bigfoot 2001-2013
50 Command Thrust 2014-2016
40-60 Command Thrust 2014- Present
75-90-115-125 2 Stroke & Optimax 2003-2014
75-90-115-125 4 Stroke 2003-Present
135-150-175-200 2 Stroke & XR6 2000-2005
150-175 Optimax & ProXS 2 Stroke 2001-2018

- 665** 40-60 2&4 Stroke 2003-2018
50 2 Stroke 2006-2014
50 4 Stroke 2016-Present
50 Command Thrust 2017-Present
55 2003-2011
- 666** 90-115 Command Thrust & ProXS CT 2014-Present
150-175-200-225-250-275-300 Verado 4.8" Gearcase 2005-2017
200-225-250 Optimax & ProXS 2 Stroke 1999-2018

SUZUKI

- 655** 150-175-200-225 2 Stroke 1986-2002,
4 Stroke 2003-2011
250SS & 300 DF 4 Stroke 2006-2011
- 658** 90-115-140 DF 4 Stroke 1998-2011
- 657** 300 DF 4 Stroke 2009-2011

YAMAHA

- 664** 50-60 High Thrust 4 Stroke 1996-Present
60-70-90 2 Stroke 1995-2009
70-75-80-90-100 4 Stroke 2003-2016
- 665** 30-40-50 2 & 4 Stroke 2001-Present
60 4 Stroke 2002-Present
- 663** 90 4 Stroke 2017-Present
115-130 2 & 4 Stroke 2001-Present
150-175-200 2 & 4 Stroke & HPDI 1984-Present
350 4 Stroke 2007-Present
I/O Sterndrive Models 1989-1993
- 655** 200 4 Stroke V6 2002-2016
225-250-300 2&4 Stroke 2004-Present
- 674** VMAX HPDI & SHO
200-225-250 4 Stroke VMAX SHO 2013-Present
200-225-250-300 2 Stroke VMAX HPDI 2004-2010



- **Protect Against Ramp Dragging, Rocks, Debris, and Submerged Objects**
- **Drain Hole Prevents Corrosion and Freezing**
- **Installs Easily in Less Than 10 Minutes**
- **A Model to Fit Virtually any Skeg**
- **Avoid Expensive Repair Costs**
- **3 Year Warranty**

Megaware SkegPro conforms to your lower unit to insure there is no discernable drag or compromise in performance. A drain hole keeps water from collecting and remaining stagnant.

Uses 3/16" Stainless Steel Screw with Nylon Locking Nut

KeelGuard.com

MEGAWARE

Scuff Buster™

**PROTECT YOUR BOAT
FROM UNSIGHTLY ROLLER
AND TRAILER SCUFFS**



Megaware ScuffBuster Products

Protect your boat from unsightly marring. Made from anti-corrosive, 22-gauge 304 stainless steel, Megaware ScuffBuster products attach to your boat's surface with the highest quality materials and 3M® pressure-sensitive adhesives.

Bow Guard

XL and Standard Sizes

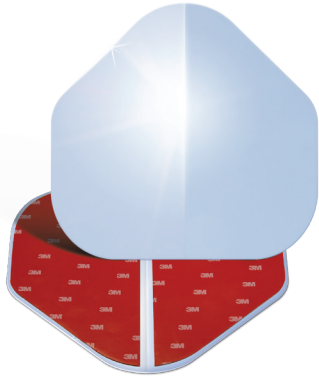

XL

9" X 8.75"

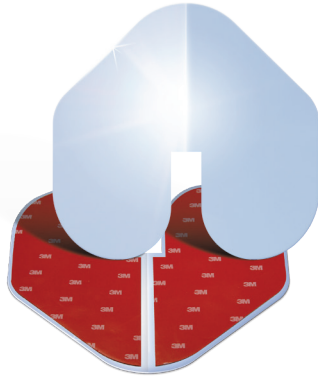

XL With Notch

9" X 8.75"



- **Protect Your Boat's Gelcoat**
- **Minimize Roller and Trailer Scuffs**
- **Bend to Conform to Hull**
- **Mirror Polished Finish**



Standard

5.75" X 4.5"



Standard With Notch

5.75" X 4.5"

KeelGuard.com

MEGAWARE

FlexStep[®]Pro

**MAKE BOATING EASIER
WITH THE ADJUSTABLE
TRAILER STEP**

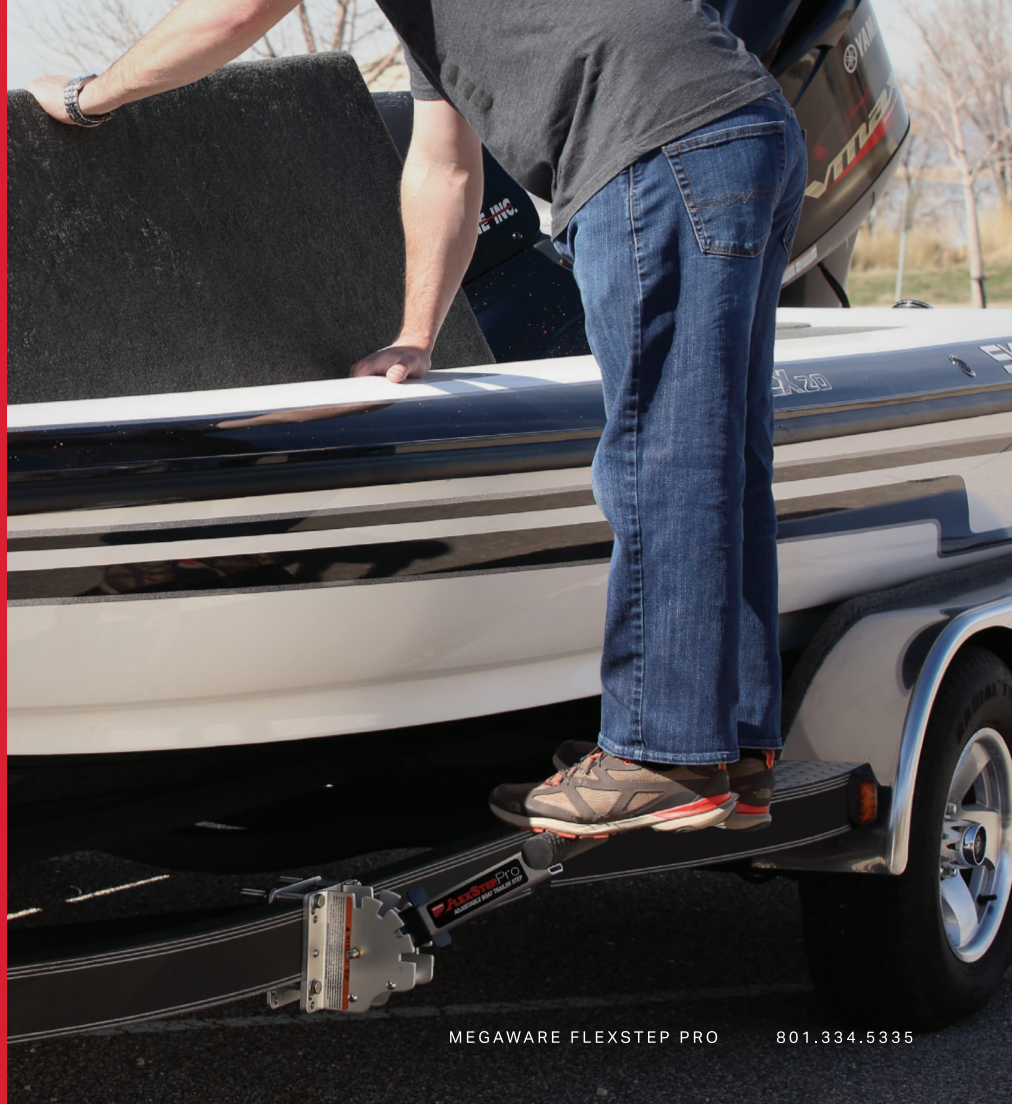

Adjustable Boat Trailer Step

Megaware FlexStep Pro makes boating more convenient than ever. This innovative multi-angle/extendable step system attaches to your trailer frame, allowing easy access to virtually anywhere on your boat. A quick, spring loaded pull handle and locking pin system adjusts the FlexStep Pro to 16 positions for maximum reach.

Using just four bolts, the Megaware FlexStep Pro mounts to your trailer frame (accommodates trailer rails up to 5 1/8" tall, and trailer tongues up to 4" wide*) in just minutes and easily disconnects with a single pin for safe storage during travel.

*Mounting to the trailer tongue may require longer bolts which can be purchased at most hardware stores.

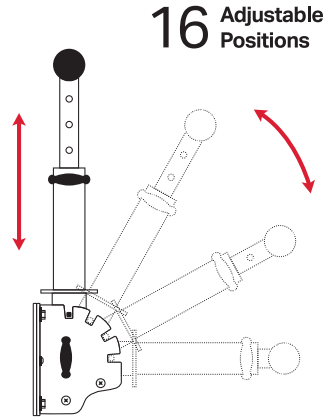

MEGAWARE
FlexStep[®]Pro

- 16 Adjustable Positions
- Extends from 17 to 21 Inches
- Removable for Safe Travel and Stowing
- Fits Most Trailer Rails
- 3 Year Warranty



**Easy Boat Entry
and Exit**



**Easy Access to
Windows and Storage**



**Easy Installation
and Stowing**

Megaware FlexStep Pro is manufactured from lightweight, high tensile 6063-T6 anodized aluminum ensuring the highest quality. Each step safely holds up to 300 lbs.

KeelGuard.com



Megaware KeelGuard Inc.

3974 Airport Road
Ogden, UT 84405

801.334.5335

KeelGuard.com